

From CHP to gates: syntax-directed translation

Rajit Manohar



A direct path from CHP to gates

- Goal: to provide a direct path from CHP to gates
- “Syntax directed”
 - ❖ Translation uses the syntax of the CHP program to generate the circuit
 - ❖ Uses structural induction
 - ▶ Induction on the *structure* of the program
 - ▶ Translations for
 - ▶ Base case: assignment, communication, skip, expression evaluation
 - ▶ Induction: selections, loops, sequential composition, parallel composition
- History
 - ❖ 1980s : multiple approaches developed
 - ❖ 1991 : Tangram language / Haste @ Handshake Solutions (Philips Research)
 - ❖ 1998 : Balsa, based on Tangram with extensions (U. Manchester)

Key idea

- Use a communication *channel* to select a program for execution
- Given a program “P”, we will implement the following

```
*[ // infinite loop
  [#C]; // wait for pending
  P; // execute P
  C? // finish C
]
```

- We execute “P” by simply executing

C!

- This is sometimes called “process decomposition” or “process call”

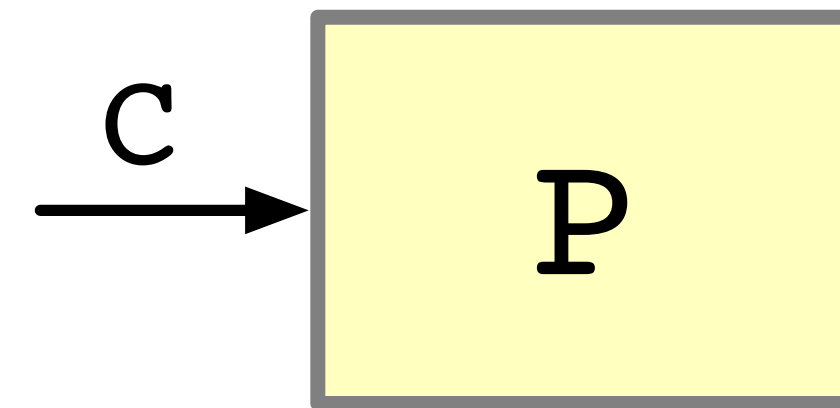

Wire implementation of channels

- Channel “C” that *controls* the execution of a program

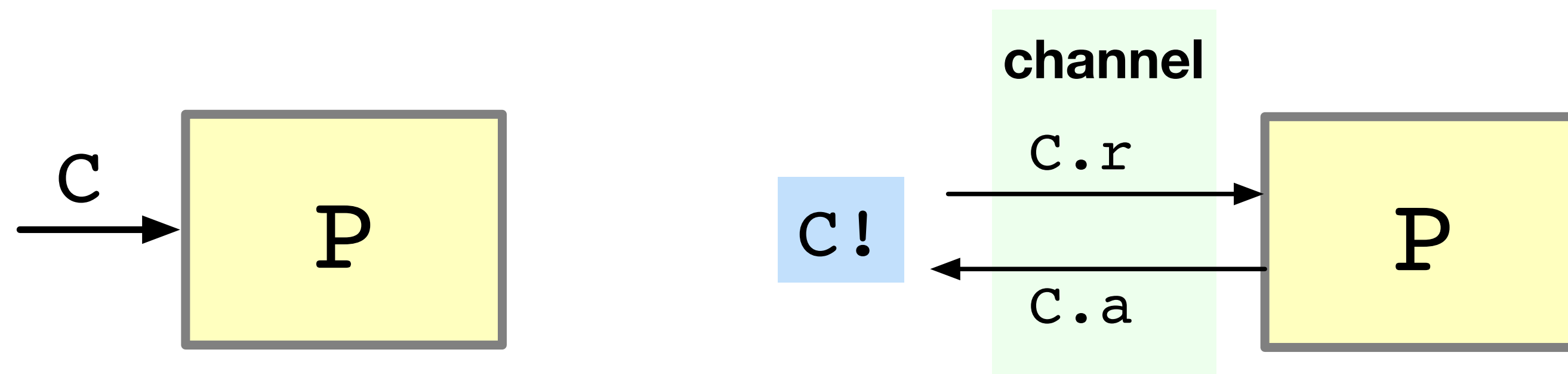
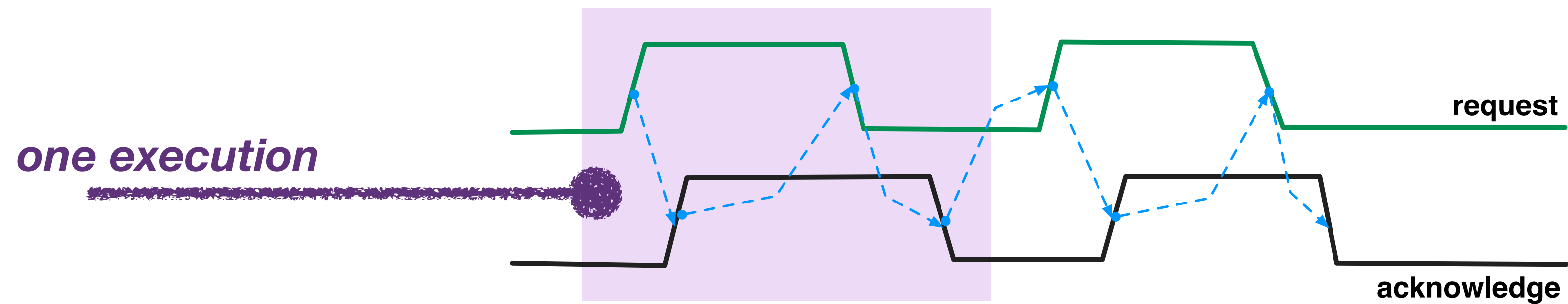

One execution: idle (waiting) state

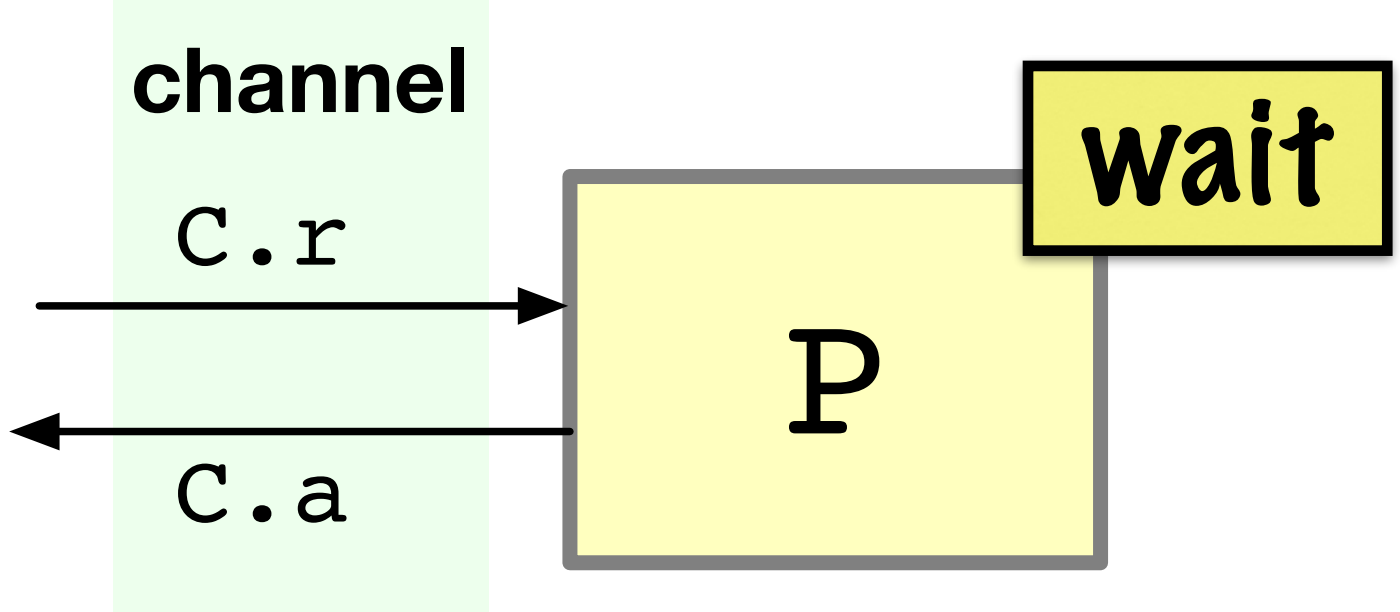
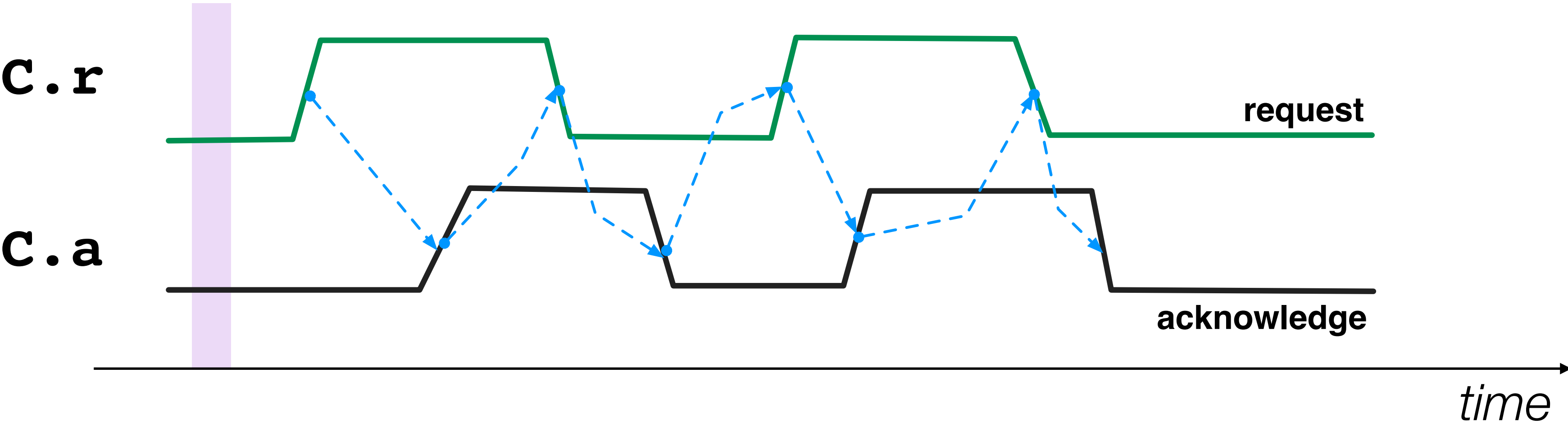

One execution: request execution

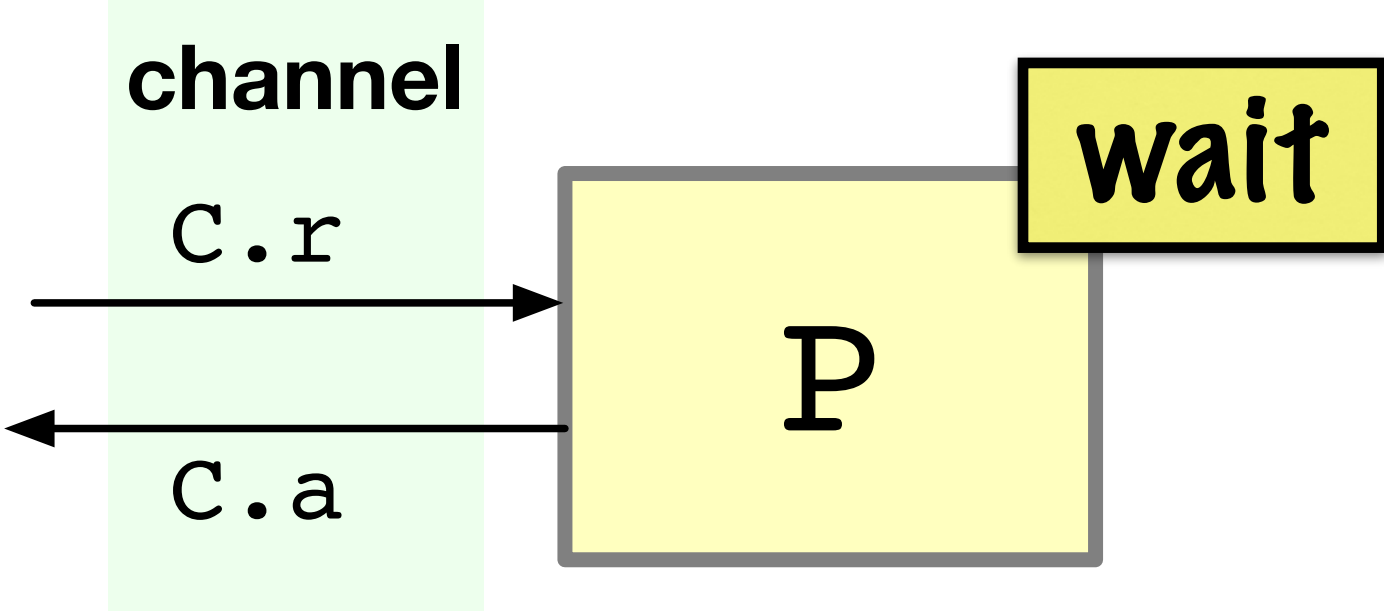
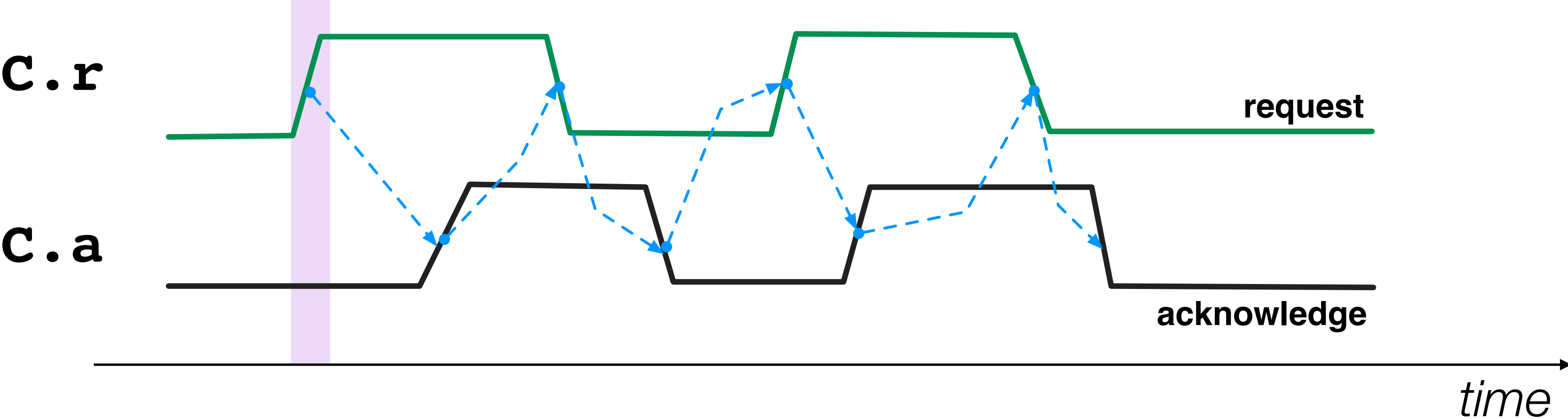

One execution: running

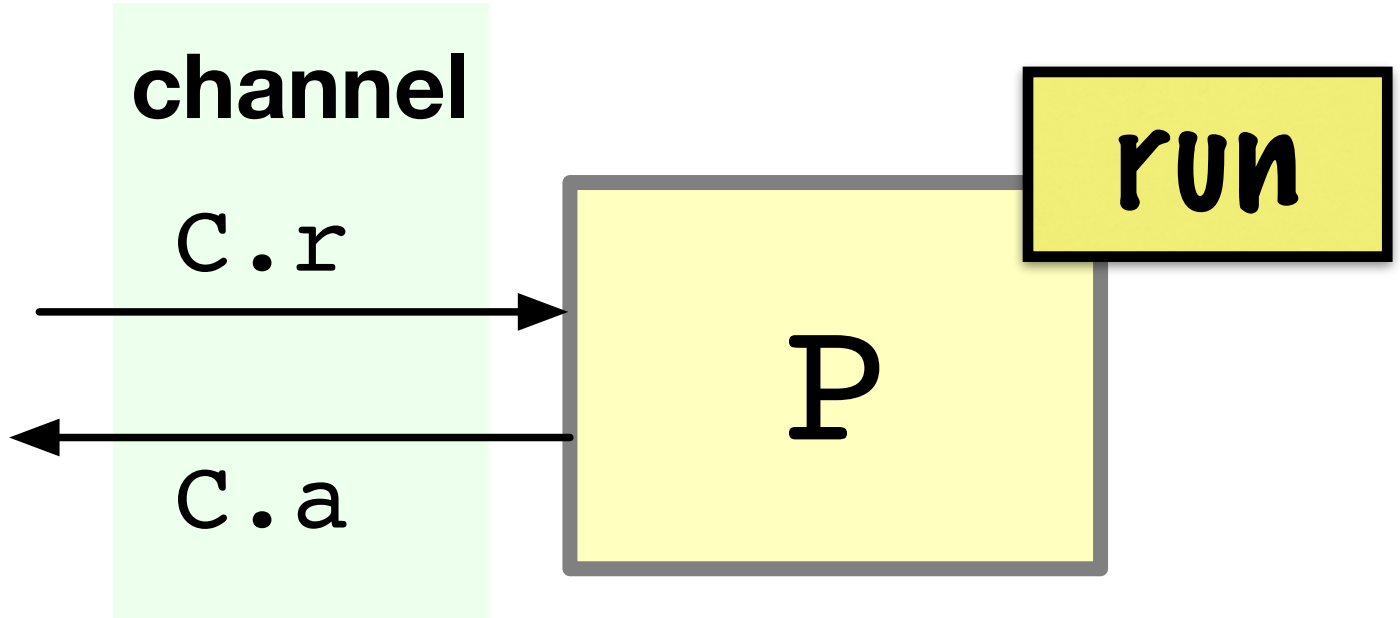
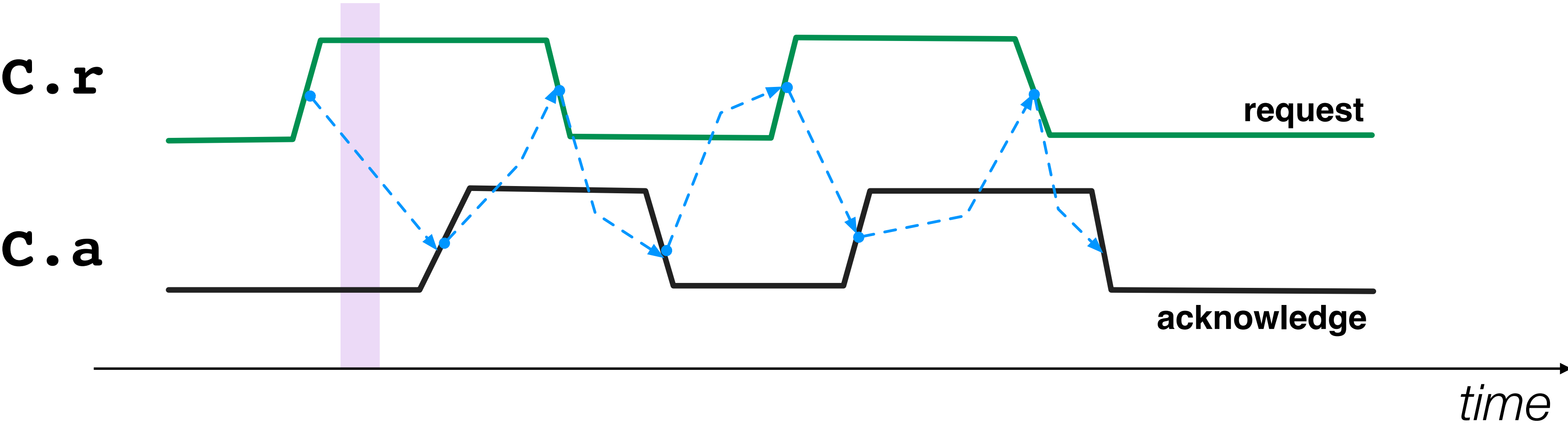

One execution: done

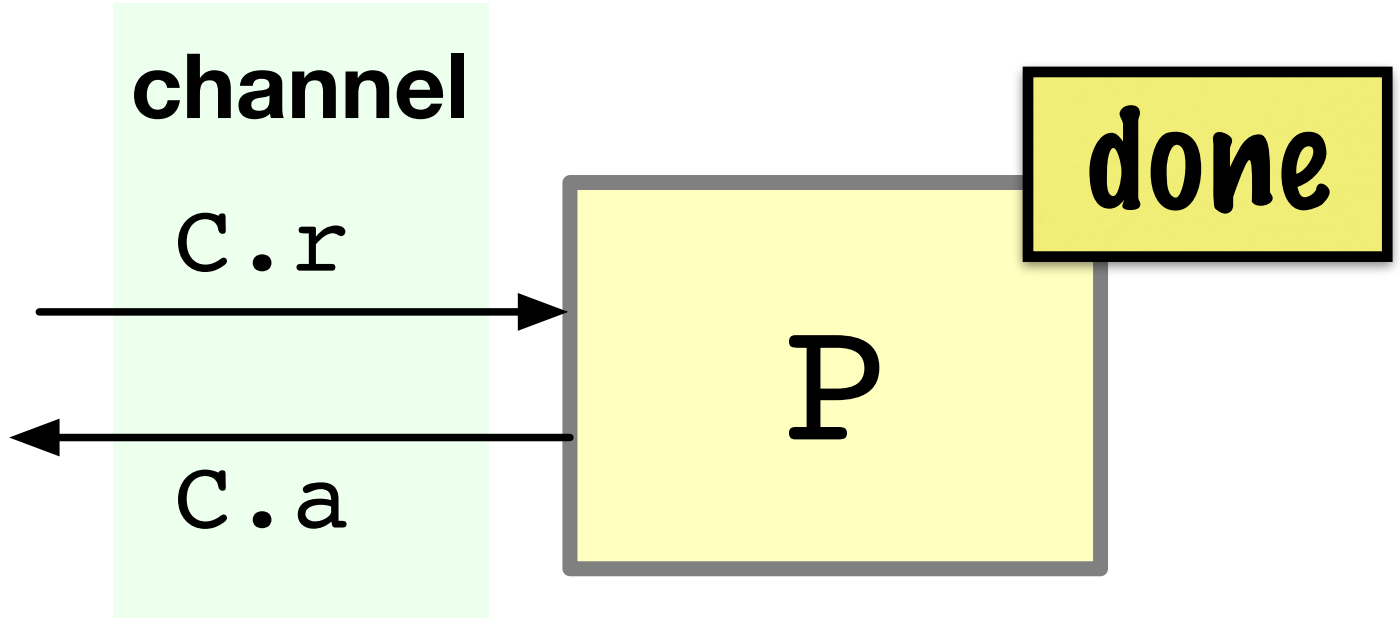
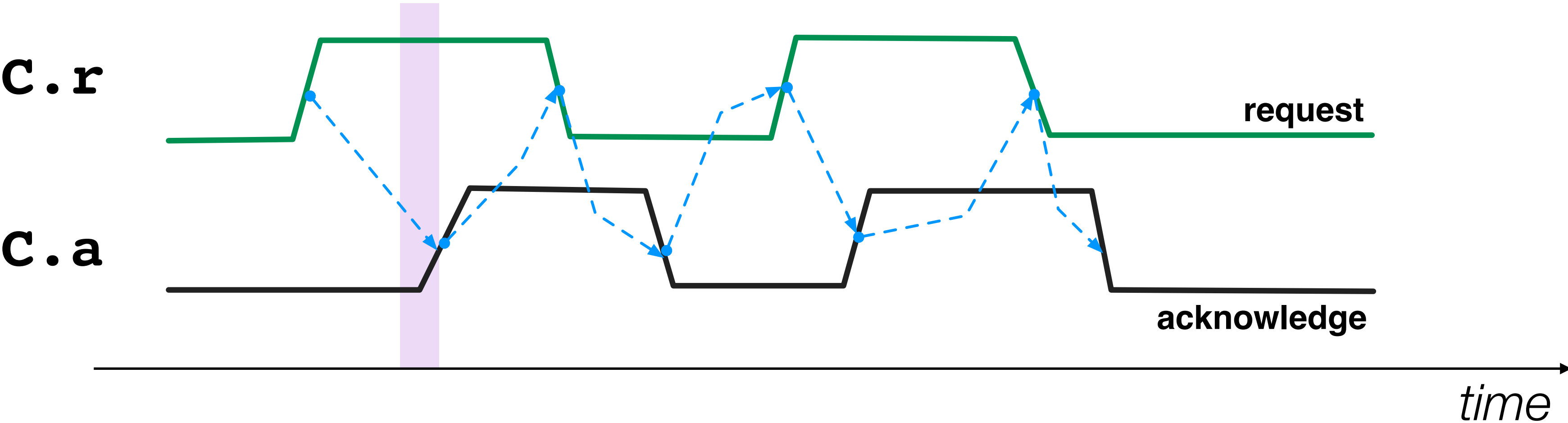

One execution: respond to requester

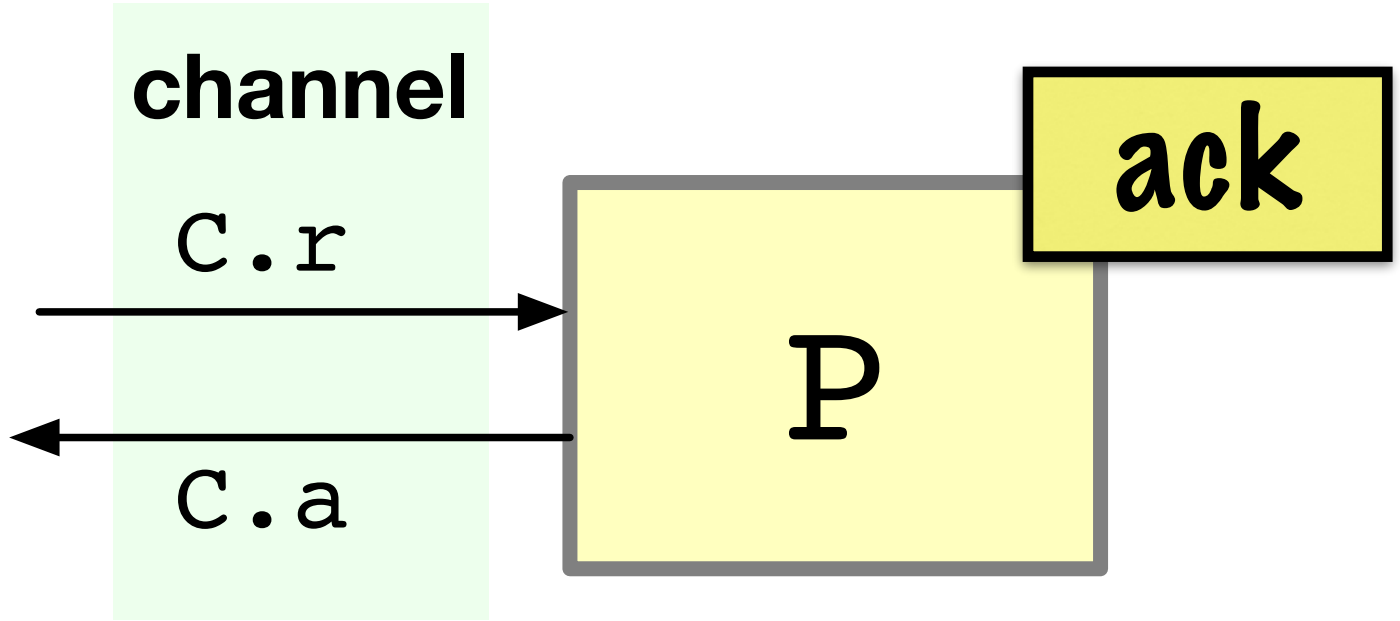
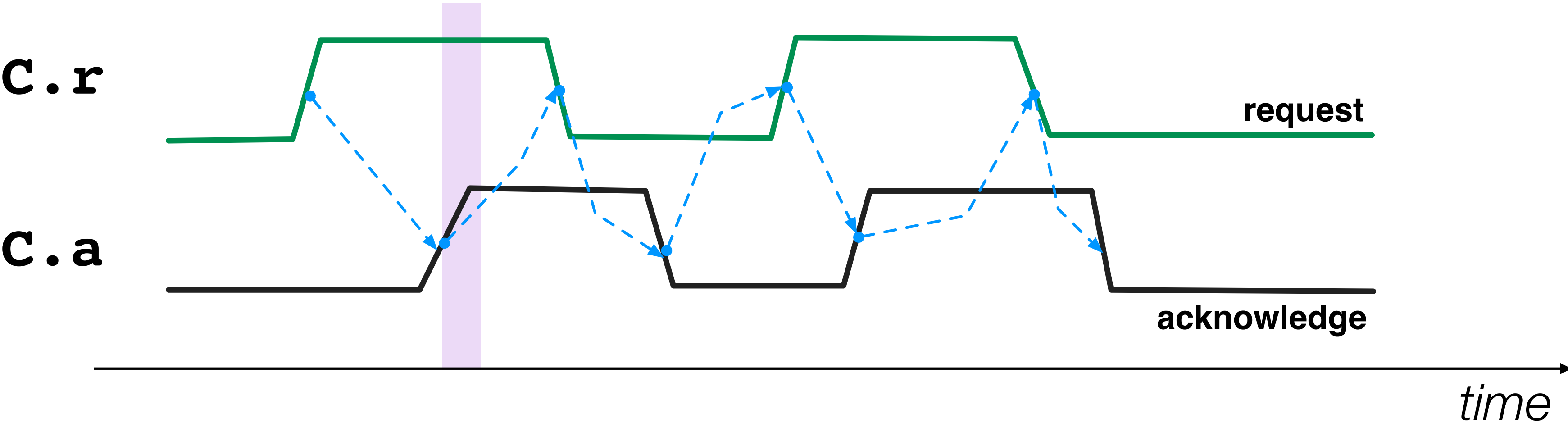

One execution: reset phase

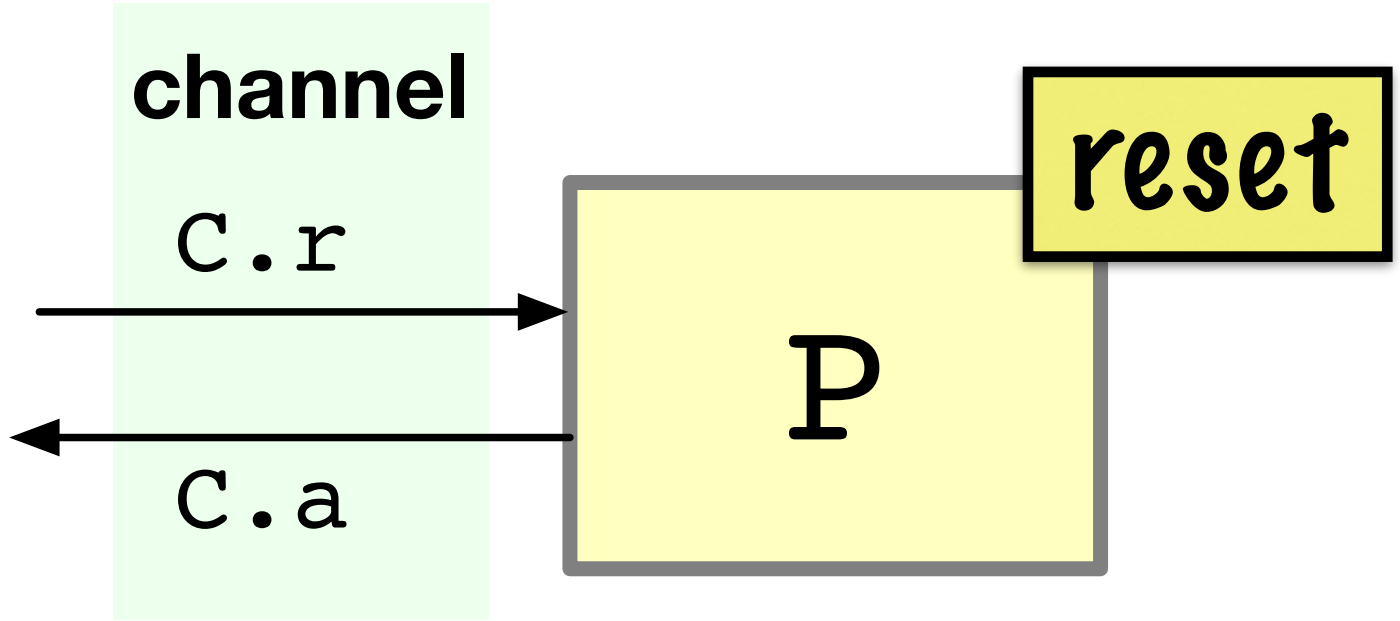
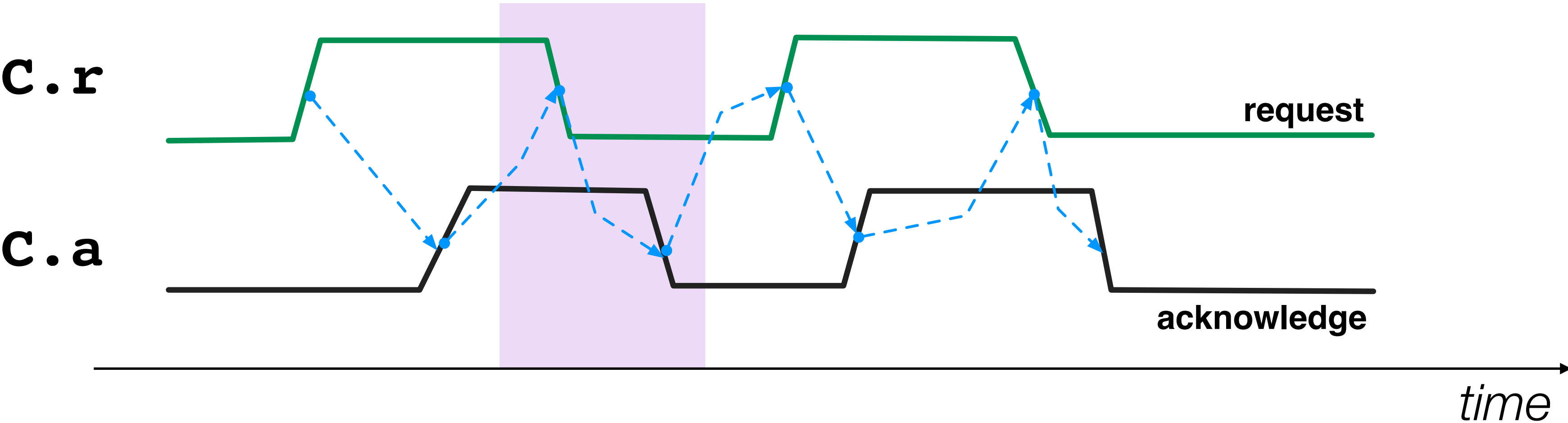

One execution: reset phase

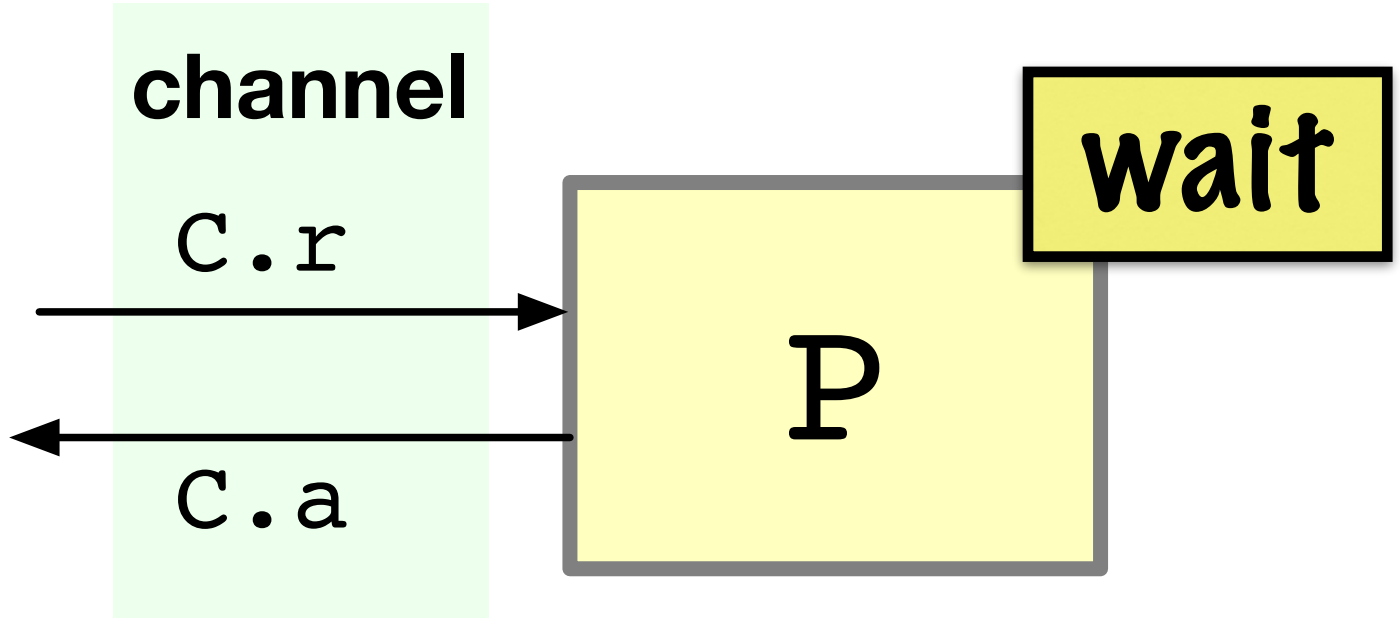
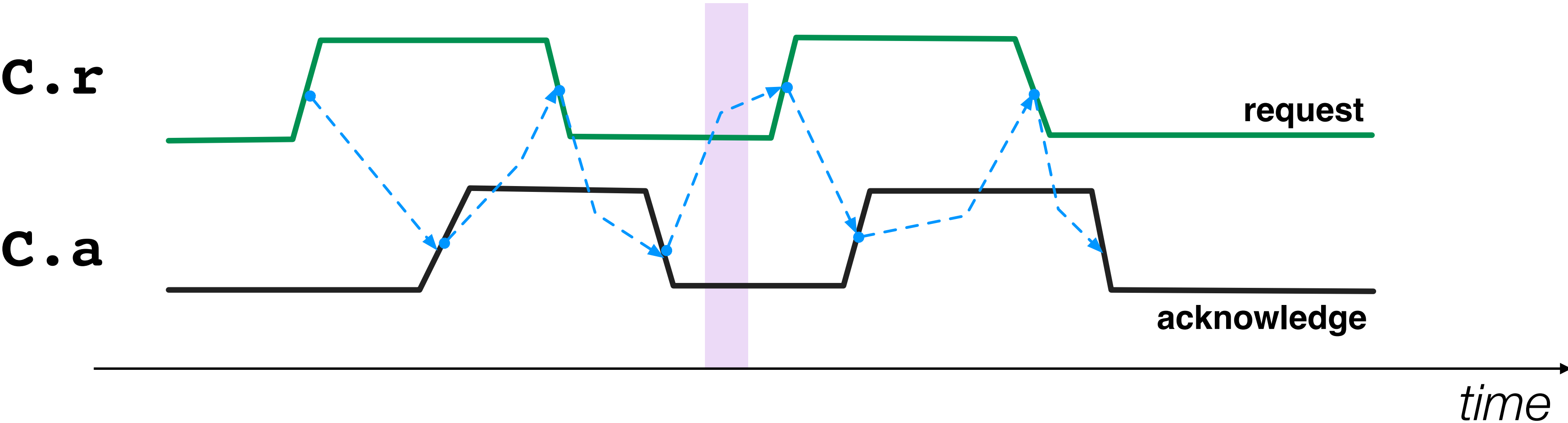

Variables

- Two operations

- ❖ Write a value to the variable

W!value

- ❖ Read the current value of the variable

R?x

- The variable itself is “passive”

- ❖ It waits for the environment to either write or read its value

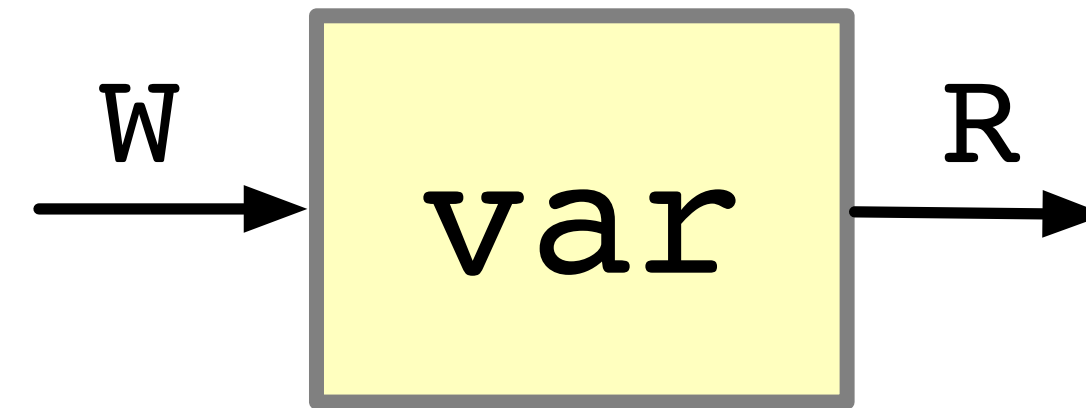

Writing and reading a variable

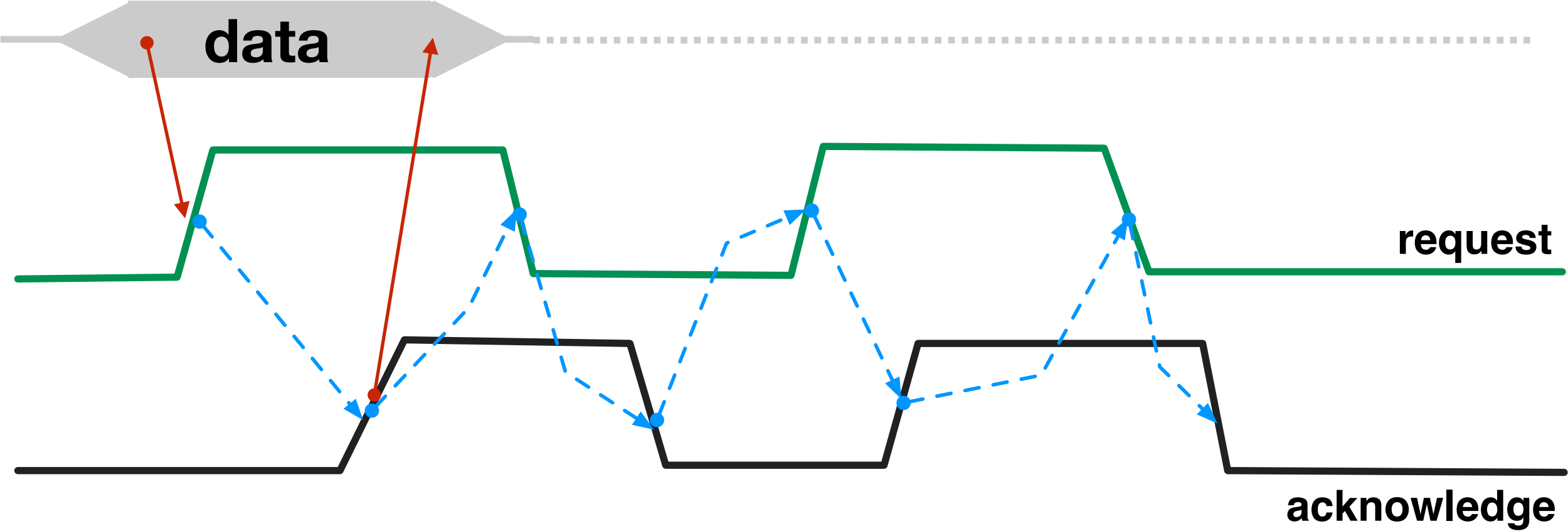
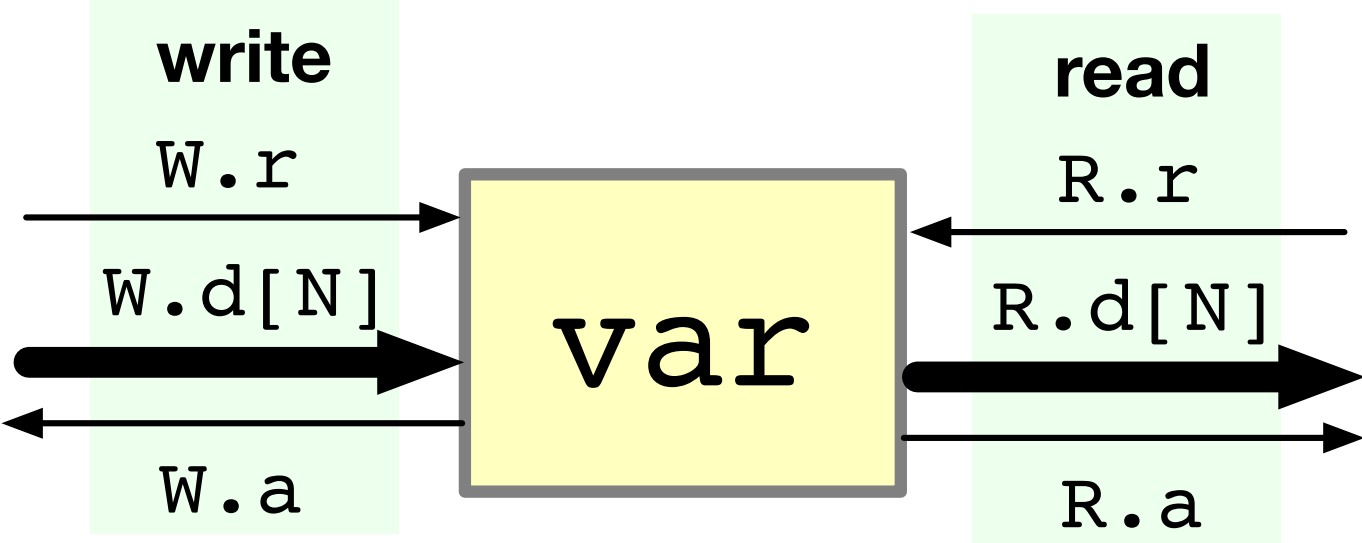

Writing and reading a variable

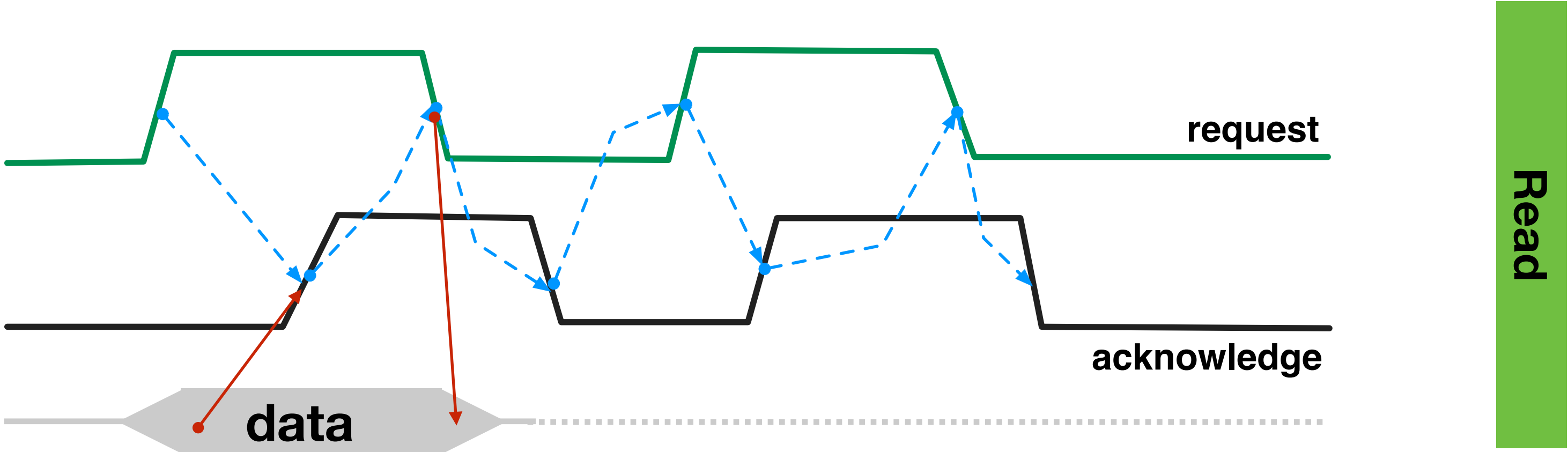
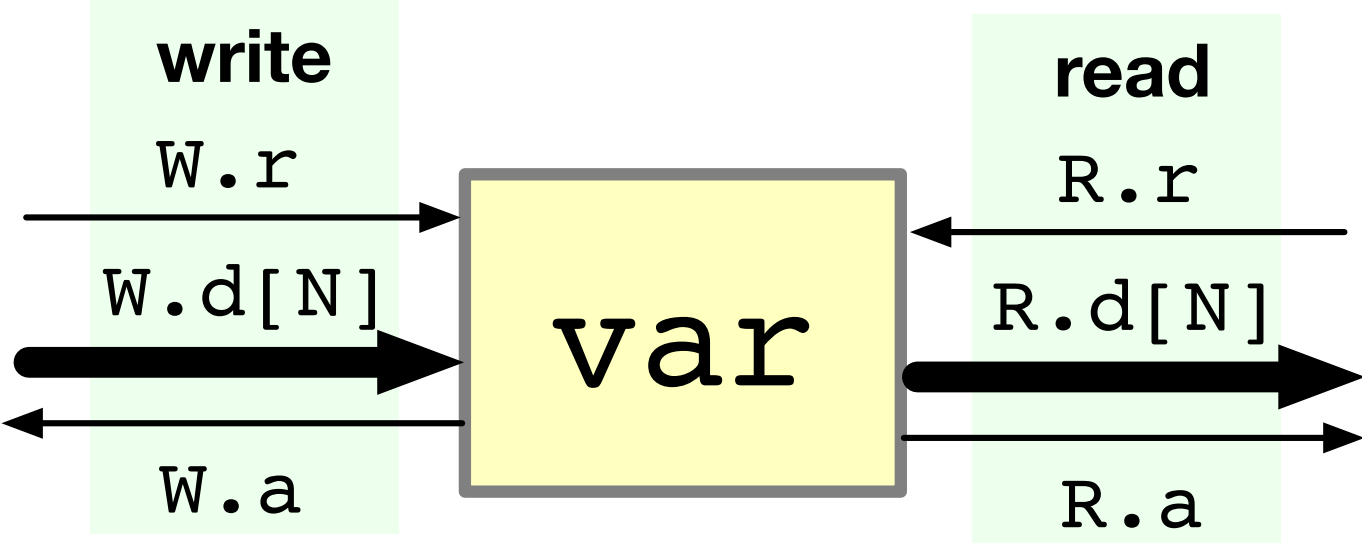

Sending and receiving on a channel

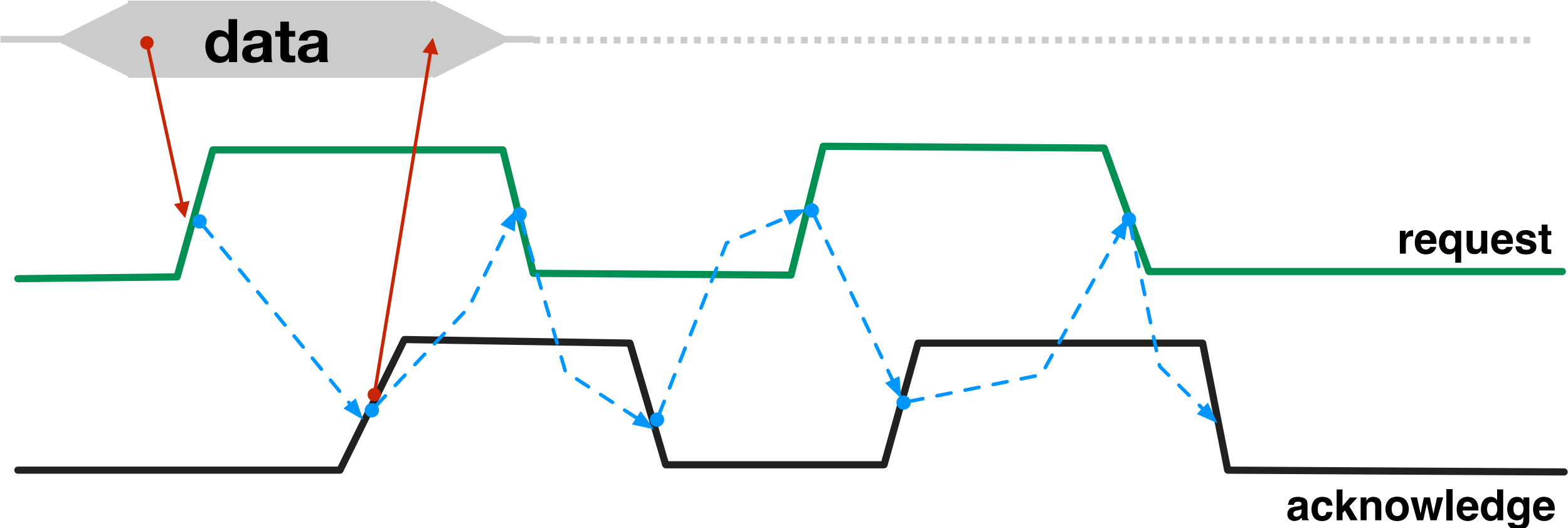
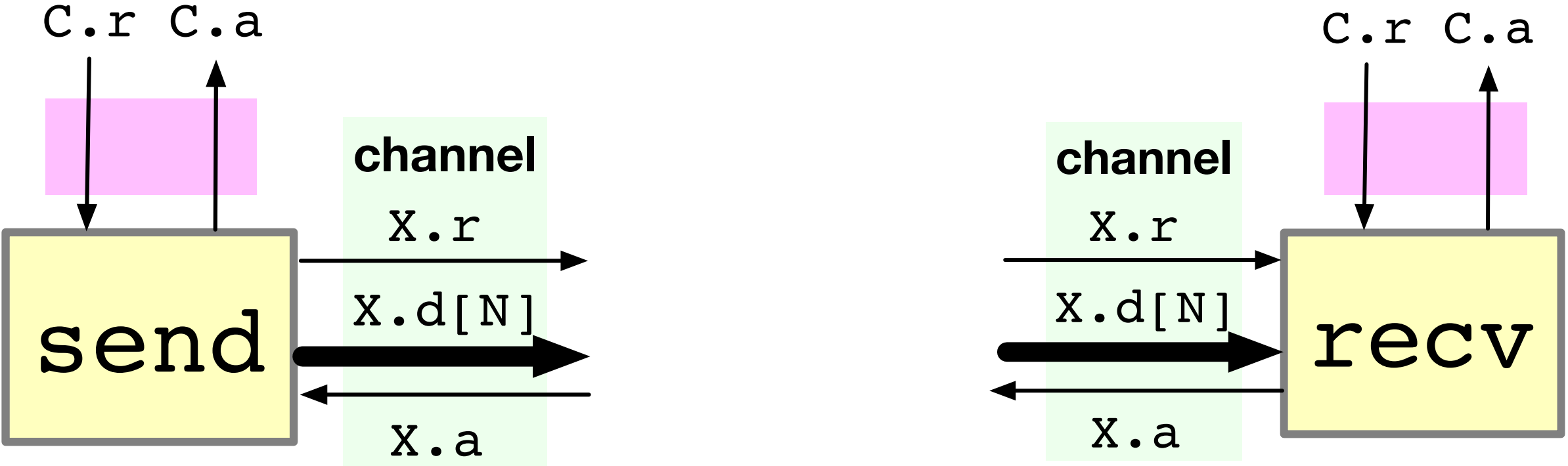

Expression evaluation

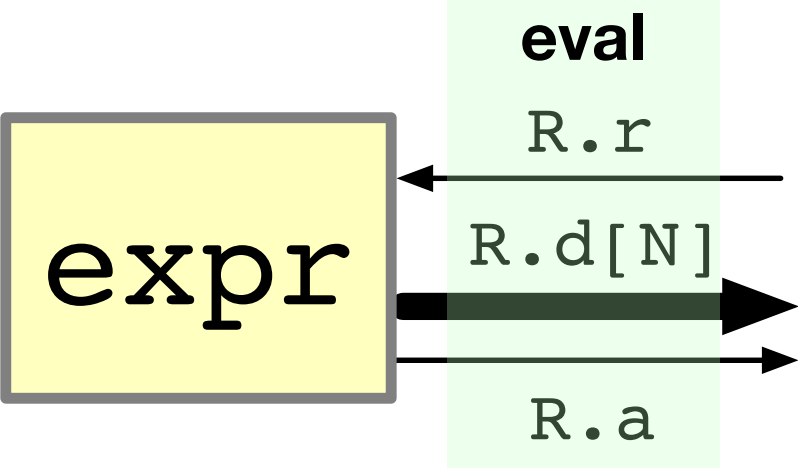

- Example of expression de-composition

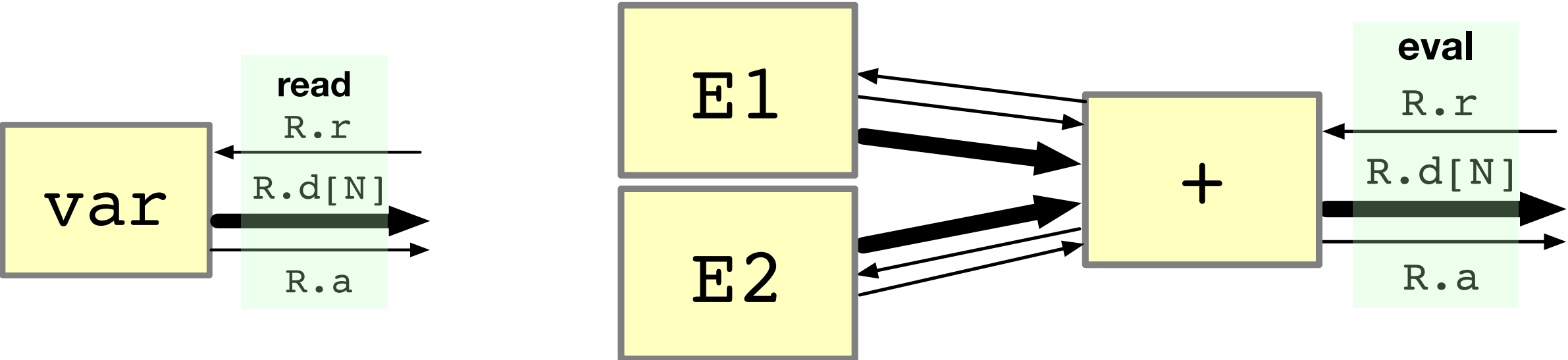

Assignment

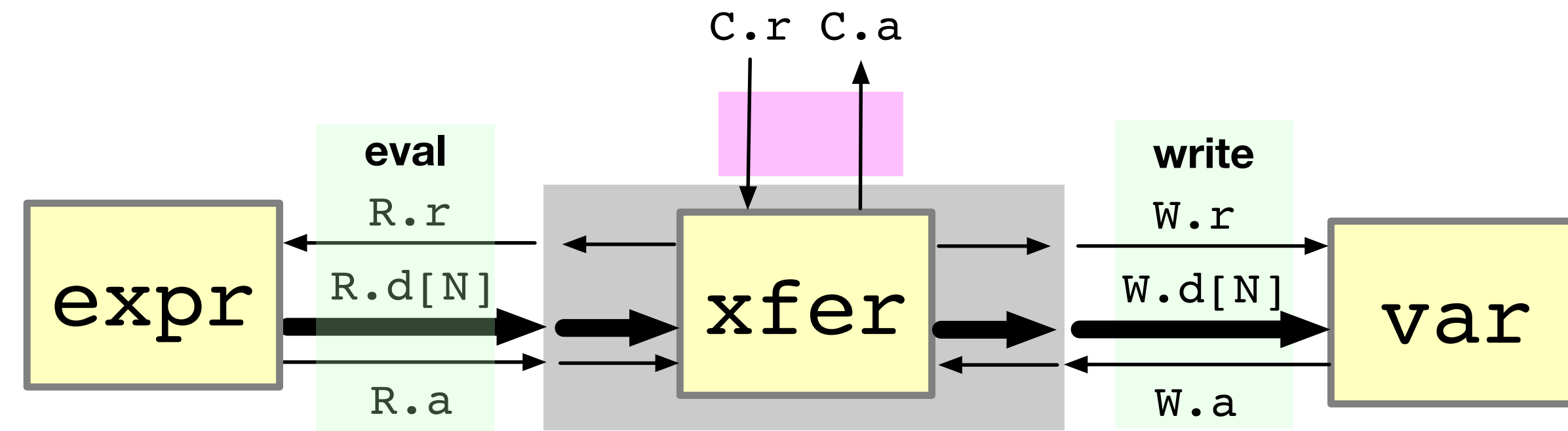

Assignment

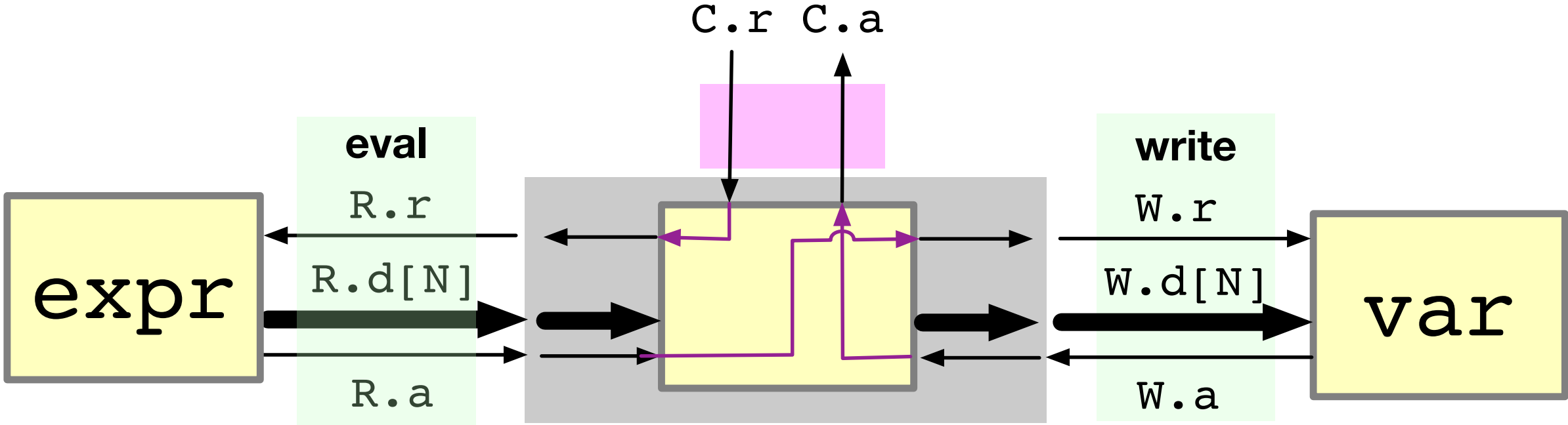
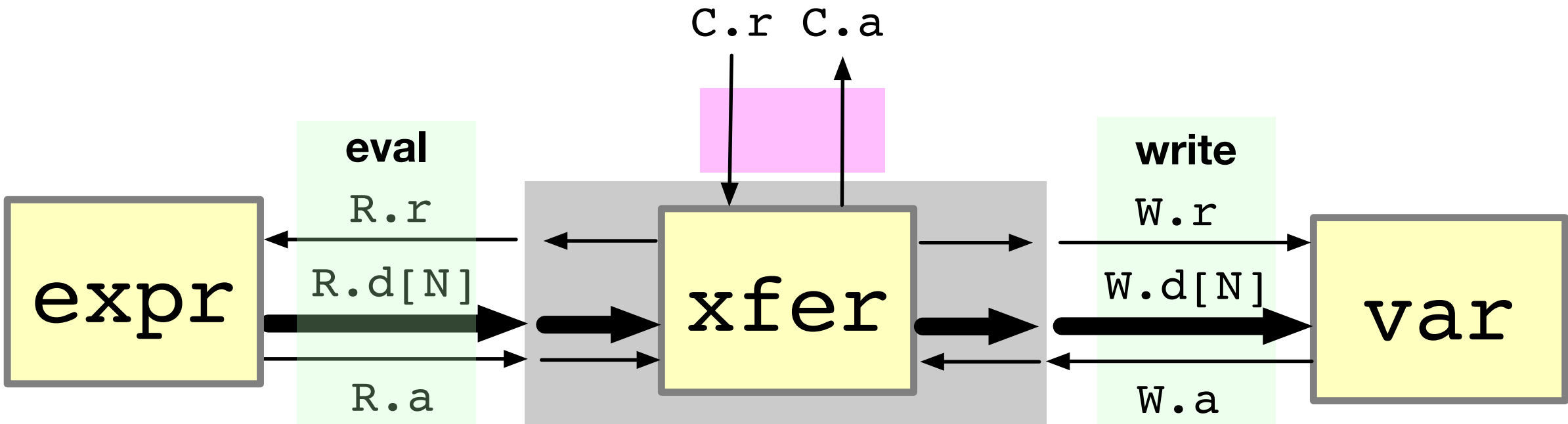

Building blocks

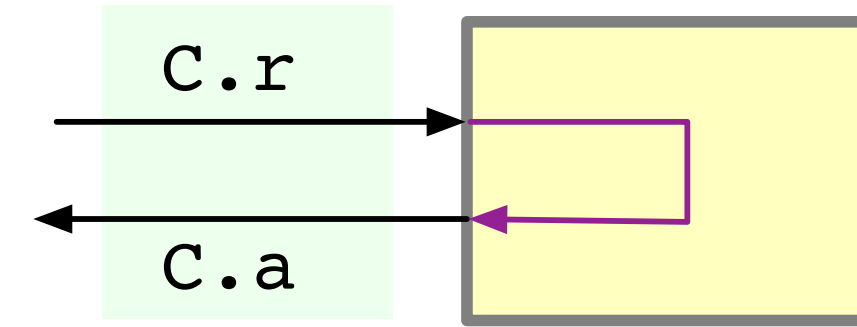
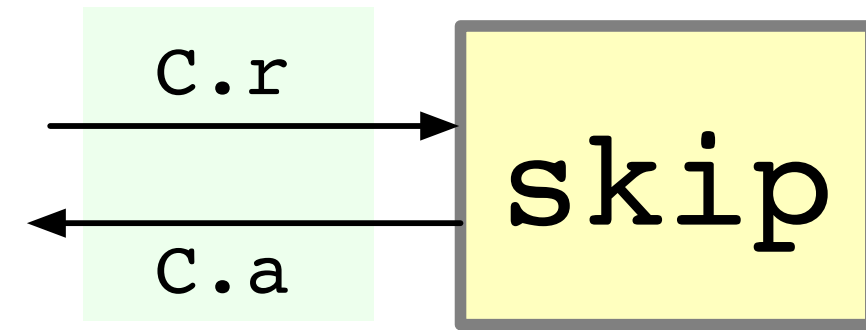

Building blocks

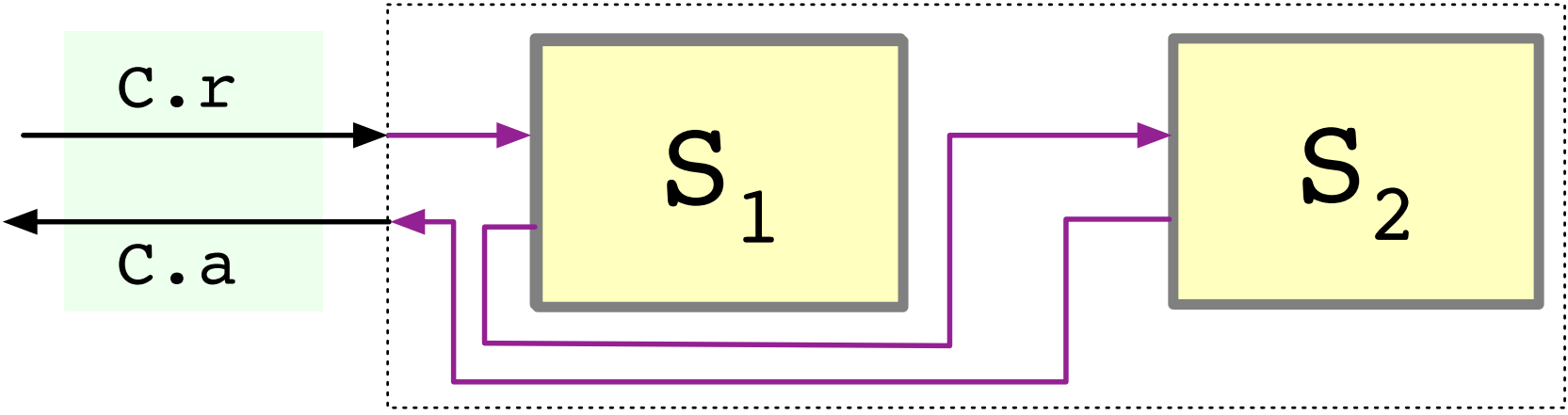
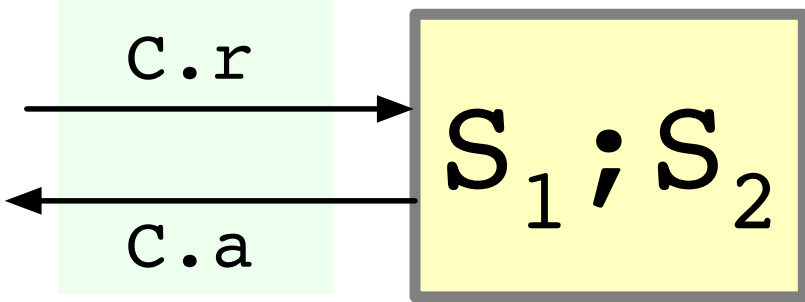
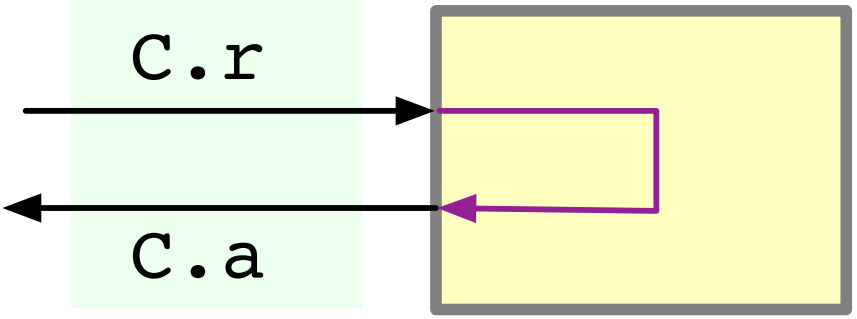
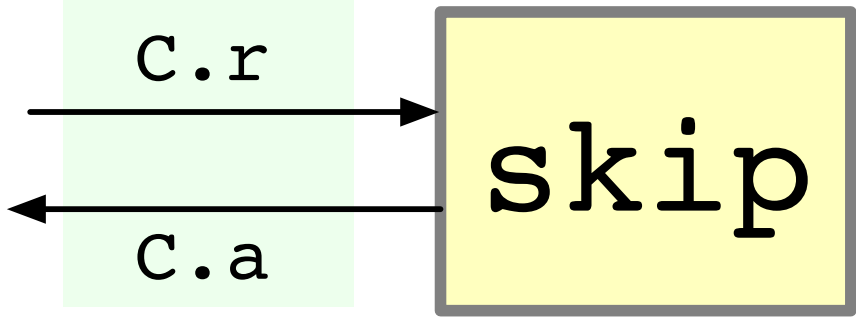

Building blocks

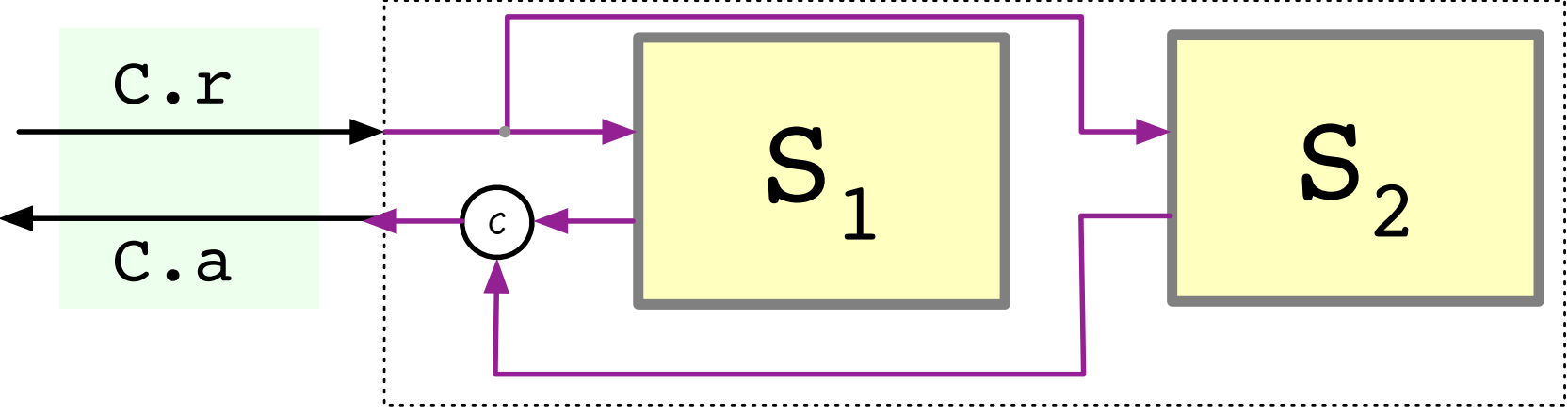
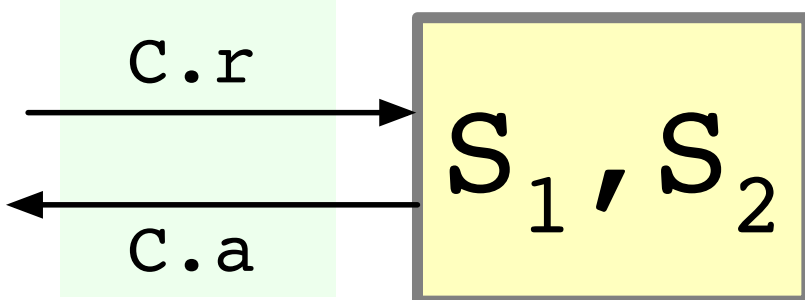
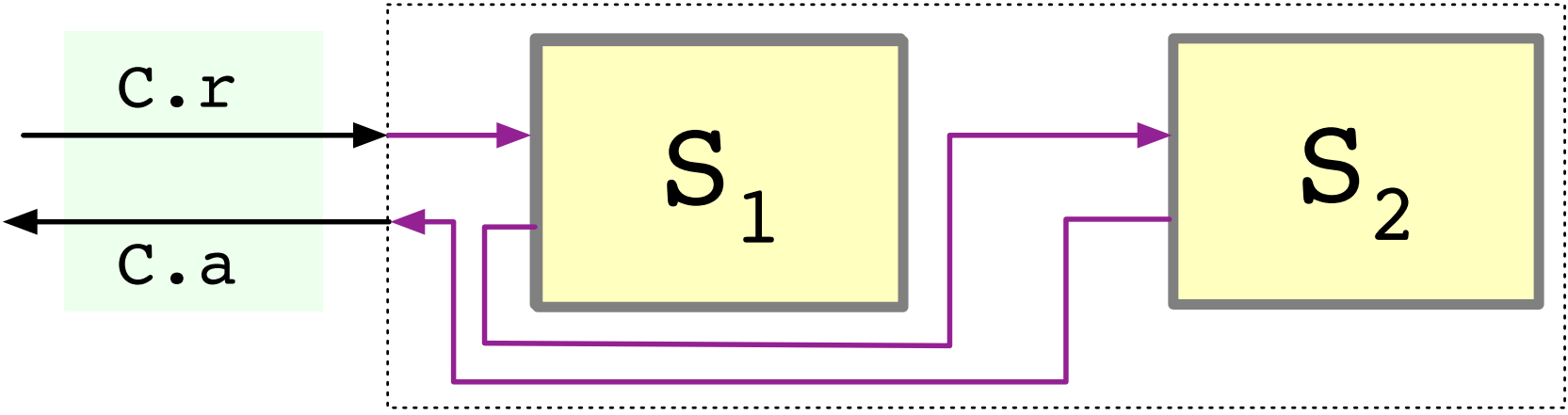
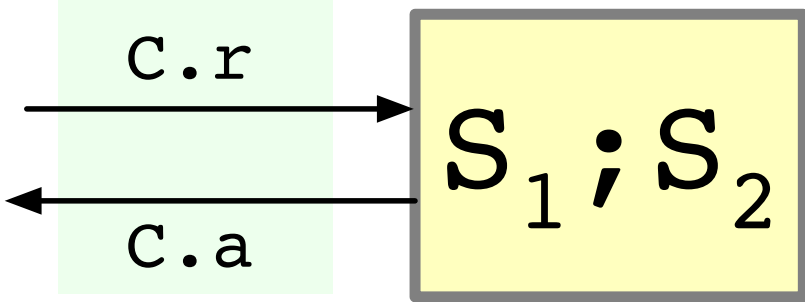
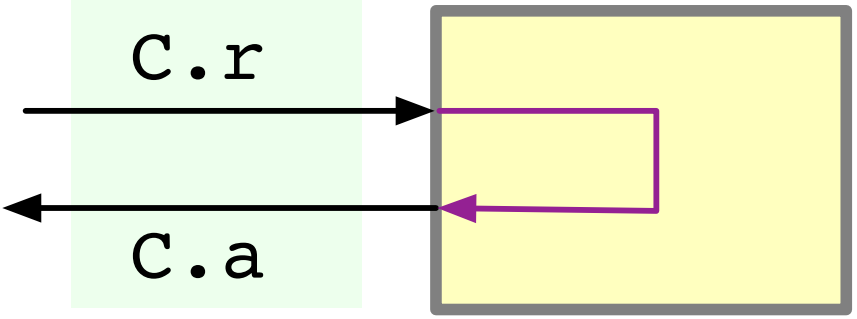
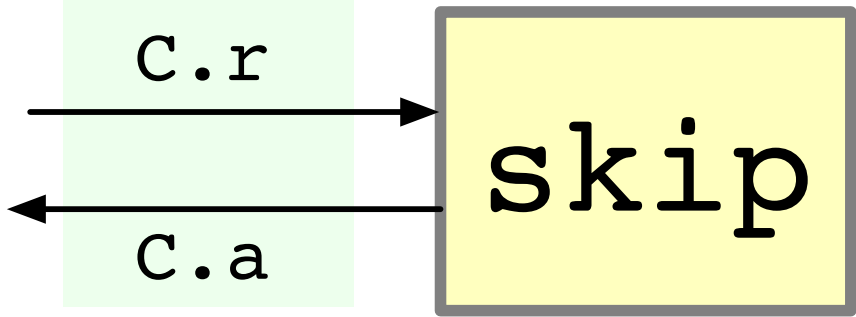

Selections and loops

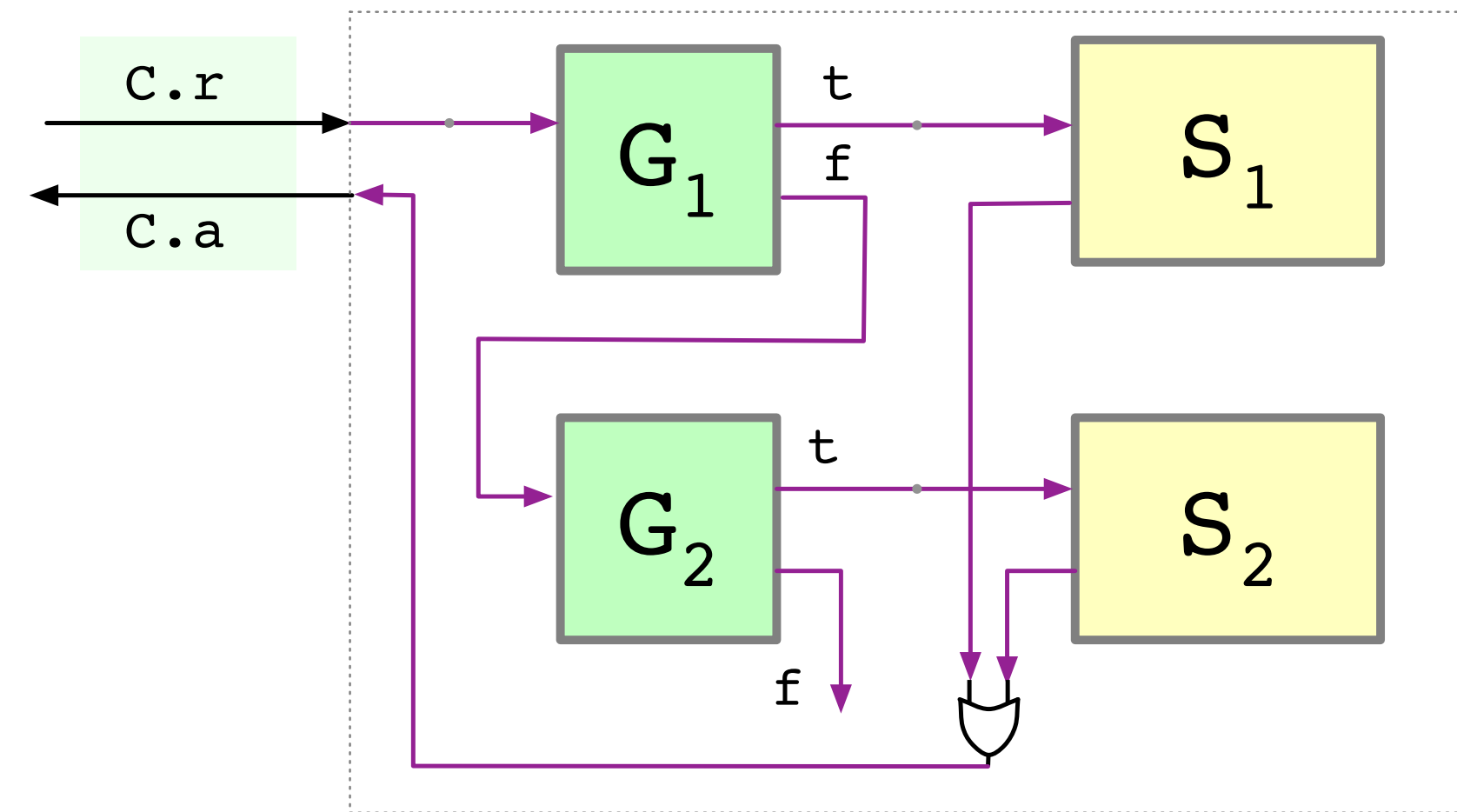

```
[ G1 -> S1
  ] G2 -> S2
]
```

Selection

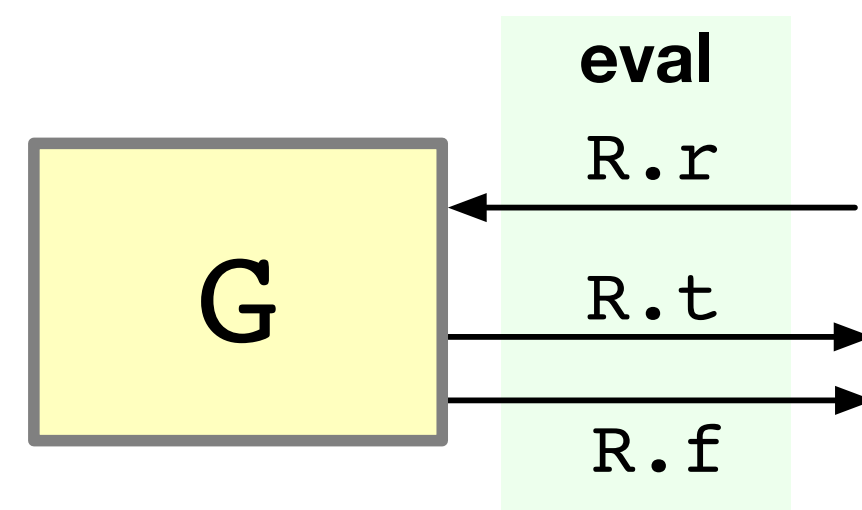

Selections and loops

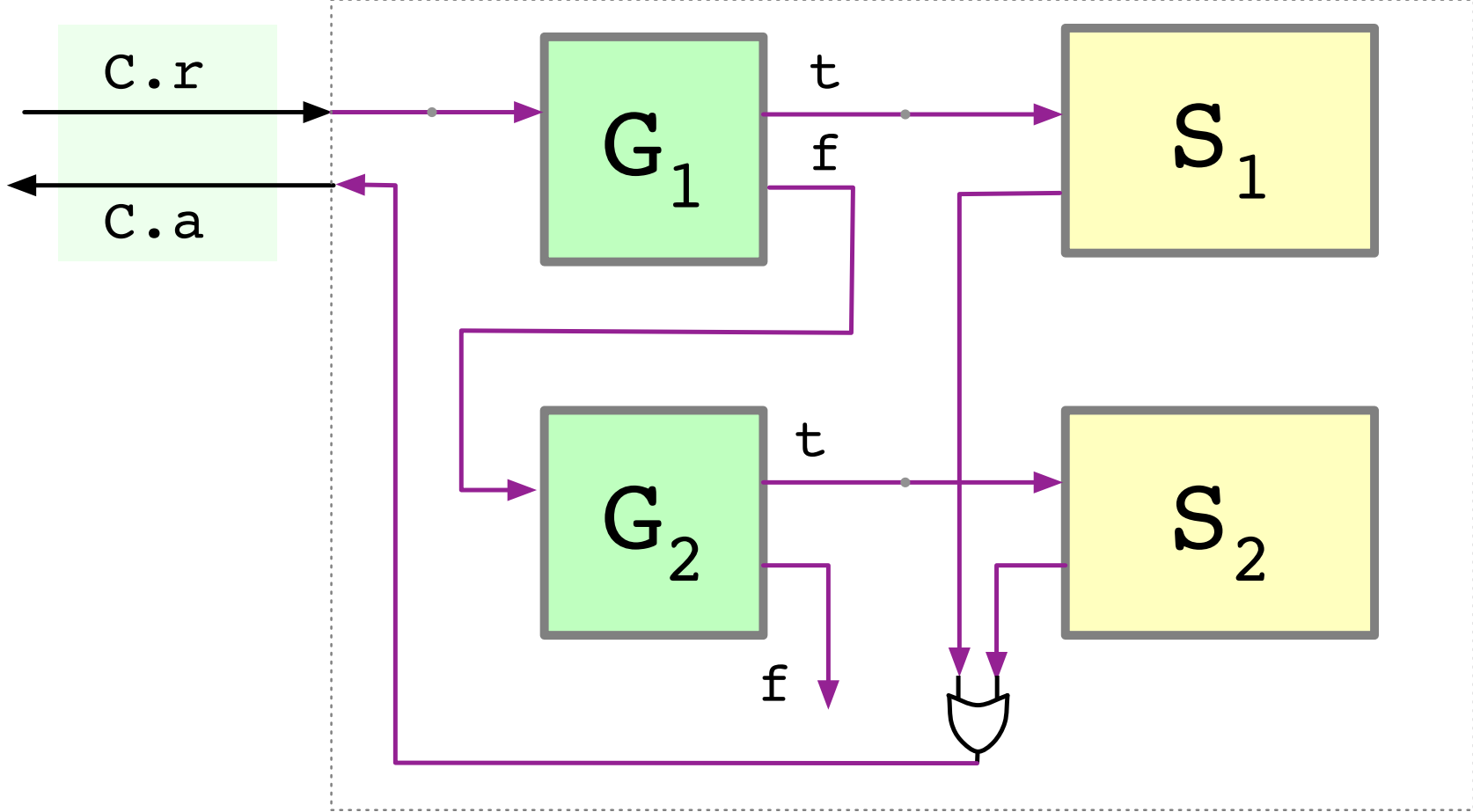

```
[ G1 -> S1
  ] G2 -> S2
]
```

Selection

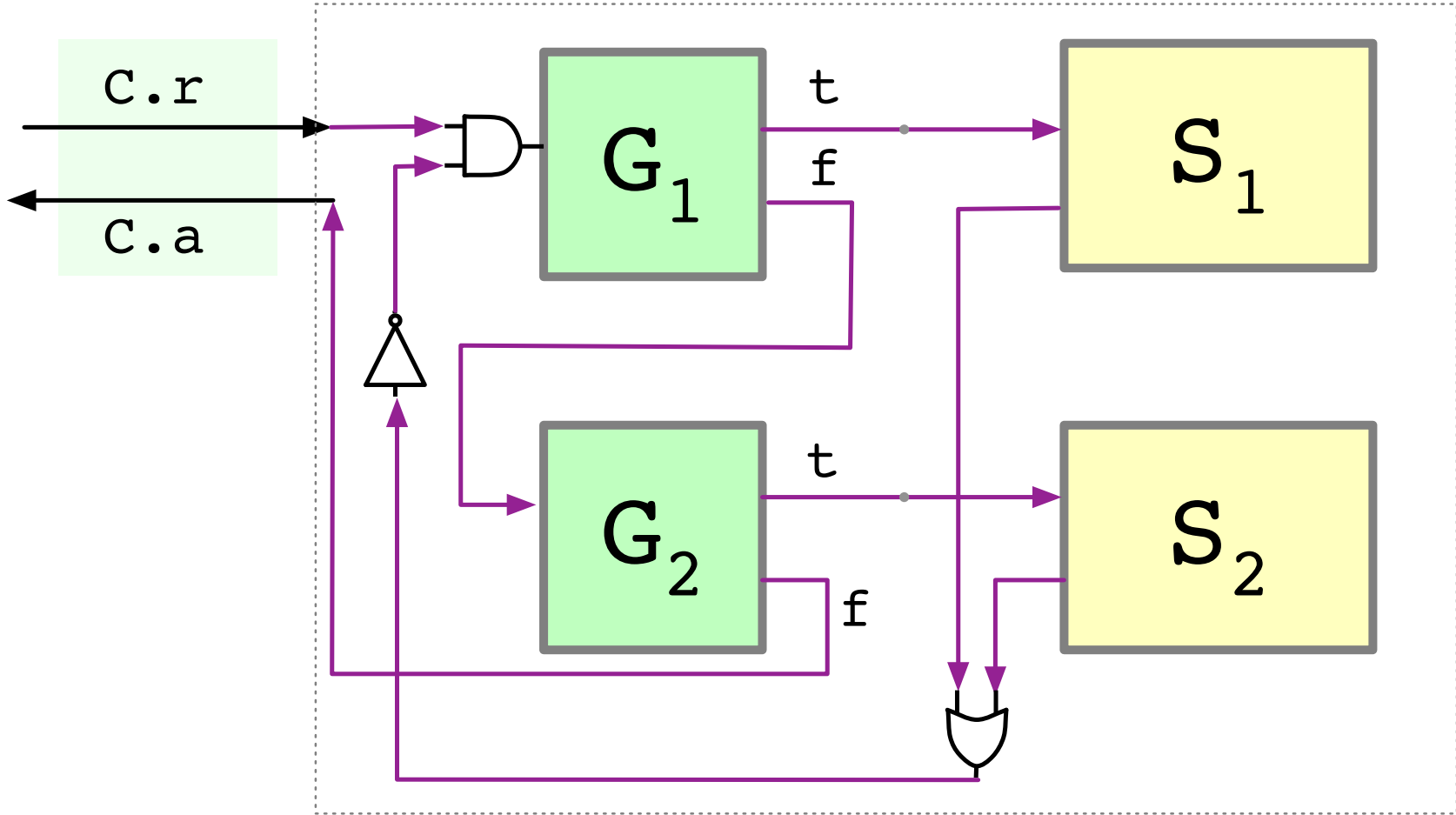

```
* [ G1 -> S1
   ] G2 -> S2
]
```

Loop